

ISSUE 7; June 2016

**Description**

- The CX1V TF quartz crystal is a high quality surface mount tuning fork resonator for use in Pierce (single inverter) oscillators. This crystal is a hermetically sealed, rugged, miniature ceramic package. They are manufactured using the Statek developed photolithographic process and were designed utilising the experience acquired by producing millions of crystals for industrial, commercial, military and medical applications.
- -C SM1 SM1 (Gold Plated, ceramic lid)
- -C SM4 SM4 (Solder Plated, ceramic lid)
- -C SM5 SM5 (Solder Dipped, ceramic lid)
- -SM1 SM1 (Gold Plated, glass lid)
- -SM4 SM4 (Solder Plated, glass lid)
- -SM5 SM5 (Solder Dipped, glass lid)
- FEATURES:
  - Miniature tuning fork design
  - High shock resistance
  - Low ageing
  - Designed for low power applications
  - Ideal for battery operated applications
  - Compatible with hybrid or PC board packaging
  - Full military testing available
- Please note that all data is only valid at 25°C unless otherwise stated.

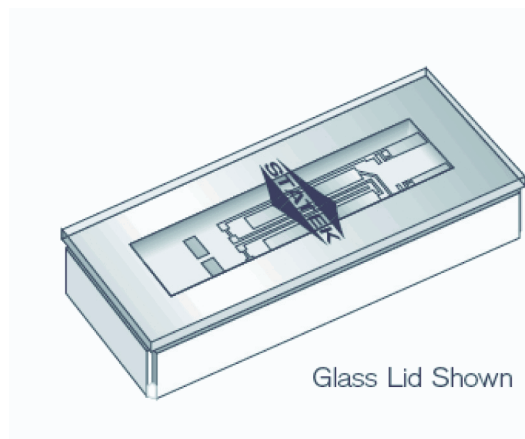

**Outline (mm) -SM1 = SM1 (Gold Plated, glass lid)**

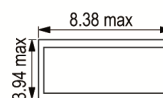

Height (H) =	Glass Lid	Ceramic Lid
SM1	1.65 max	1.78 max
SM2	1.70 max	1.83 max
SM3	1.78 max	1.90 max
SM4	1.70 max	1.83 max
SM5	1.78 max	1.90 max

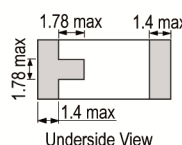

Solder Pad Layout

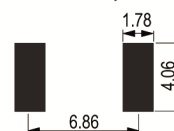

**Frequency Parameters**

- Frequency 10.0kHz to 600.0kHz
- Frequency Tolerance ±30.00ppm to ±5,000.00ppm
- Tolerance Condition @ 25°C
- Ageing ±5ppm max in 1st year @ 25°C
- Temperature Coefficient (k): -0.035ppm/°C<sup>2</sup>
- Note: Frequency f at temperature T is related to frequency fo at turning point temperature To by:  $(f-f_0)/f_0 = k(T-T_0)^2$

**Electrical Parameters**

- Load Capacitance (CL) 4.0pF to 11.0pF
- Shunt Capacitance (C0) 2pF max
- Drive Level: 10-24.9kHz 0.5µW max, 25-600kHz 1.0µW max

**Operating Temperature Ranges**

- -10 to 70°C
- -40 to 85°C
- -55 to 125°C

**Environmental Parameters**

- Shock: 1000G, 1ms, 1/2 sine
- Vibration: 20G rms, 10-2000Hz
- Storage Temperature Range: -55 to 125°C

**Manufacturing Details**

- Maximum Process Temperature: 260°C for 20sec max

**Sales Office Contact Details:**

UK: +44 (0)1460 270200  
Germany: 0800 1808 443

France: 0800 901 383  
USA: +1.760.318.2824

Email: [info@iqdfrequencyproducts.com](mailto:info@iqdfrequencyproducts.com)  
Web: [www.iqdfrequencyproducts.com](http://www.iqdfrequencyproducts.com)

**Ordering Information**

- Frequency\*
- Model\*
- Lid Variant\*
- Termination Variant\*
- Frequency Tolerance (@ 25°C)\*
- Operating Temperature Range\*
- Load Capacitance  
(\*minimum required)
- Lid Variants:  
Blank = Glass  
C = Ceramic
- Termination Variants:  
SM1 = Gold Plated  
SM4 = Solder Plated  
SM5 = Solder Dipped  
Note: non-RoHS compliant terminations SM2 & SM3 are available - please contact an IQD Sales Office
- Example:  
100.0kHz CX1V TF-C SM1  
100/-/40 to 85C/5 FUND

**Compliance**

- RoHS Status (2011/65/EU)      Optional
- REACH Status                      Compliant
- MSL Rating (JDEC-STD-033):    Not Applicable

**Packaging Details**

- Pack Style: Reel      Tape & reel in accordance with EIA-481-D  
Pack Size: 1,000
- Pack Style: Tray      Tray pack  
Pack Size: 1

**CX1V TF typical Motional Resistance**

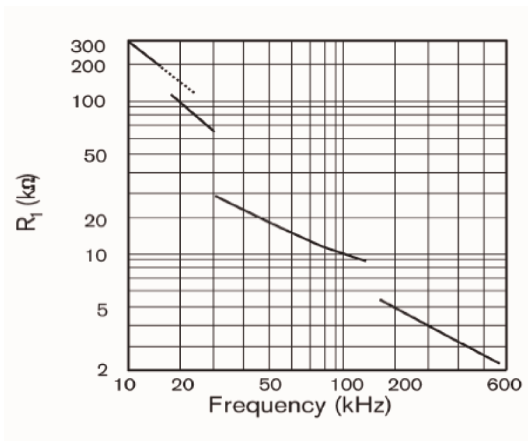

**CX1V TF typical Quality Factor**

**CX1V TF typical Motional Capacitance**

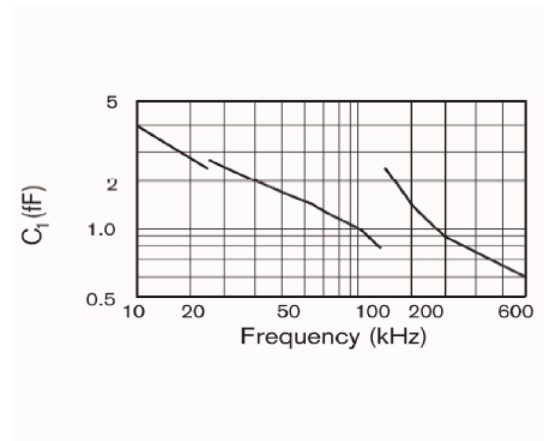

**CX1V TF typical Turning Point Temperature**

**Sales Office Contact Details:**

UK: +44 (0)1460 270200  
Germany: 0800 1808 443

France: 0800 901 383  
USA: +1.760.318.2824

Email: [info@iqdfrequencyproducts.com](mailto:info@iqdfrequencyproducts.com)  
Web: [www.iqdfrequencyproducts.com](http://www.iqdfrequencyproducts.com)

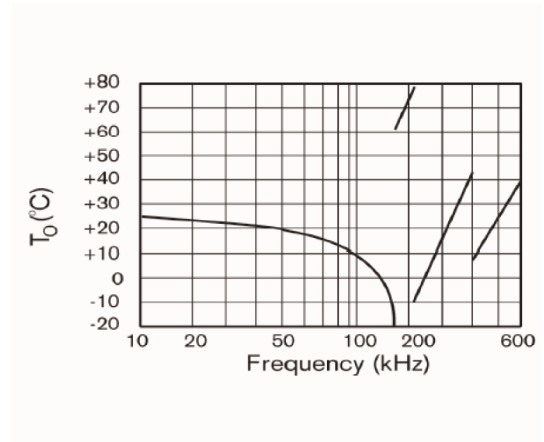
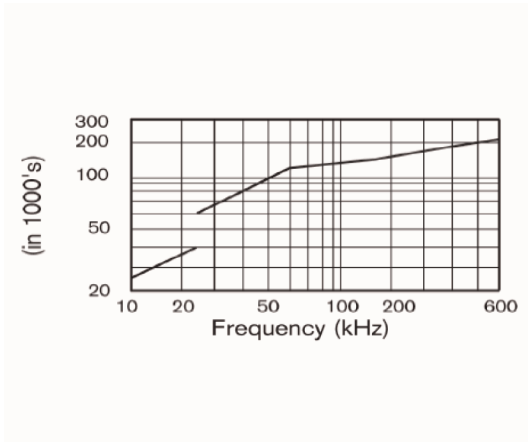

**Electrical Specification - maximum limiting values**

Frequency Min	Frequency Max	Temperature Range	Stability (Min)	Over Tone Order	ESR
		°C	ppm		Ω
10.00kHz	600.0kHz	-10 to 70 -40 to 85 -55 to 125		Fundamental	- - -

\*Stability Maximum values ±0ppm

This document was correct at the time of printing; please contact your local sales office for the latest version.

[Click to view latest version on our website.](#)

**Sales Office Contact Details:**

UK: +44 (0)1460 270200  
Germany: 0800 1808 443

France: 0800 901 383  
USA: +1.760.318.2824

Email: [info@iqdfrequencyproducts.com](mailto:info@iqdfrequencyproducts.com)  
Web: [www.iqdfrequencyproducts.com](http://www.iqdfrequencyproducts.com)